

# DOCUMENTACIÓN TÉCNICA



Ref.: MARVLL

Valla Entre Mares

UNE EN 1176-1:2018



Estructura metálica termolacada

Componentes plásticos: Polietileno de alta densidad con protección UV

Tornillería protegida con tapones de polipropileno

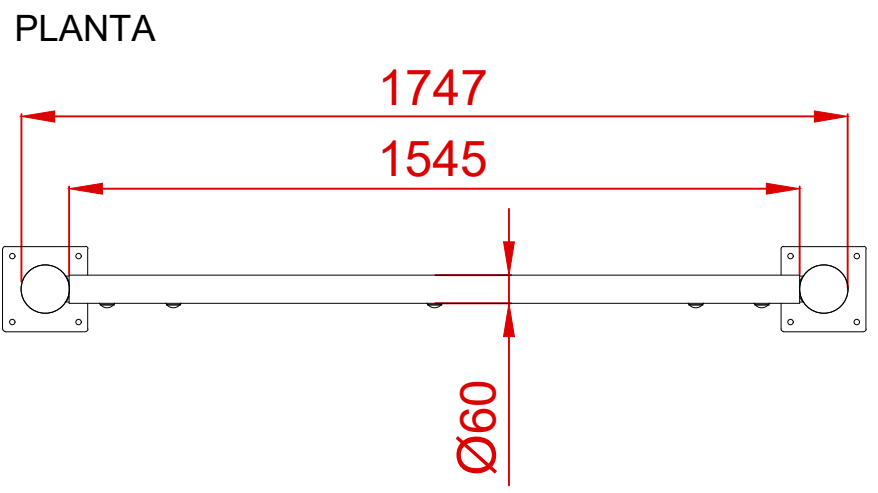
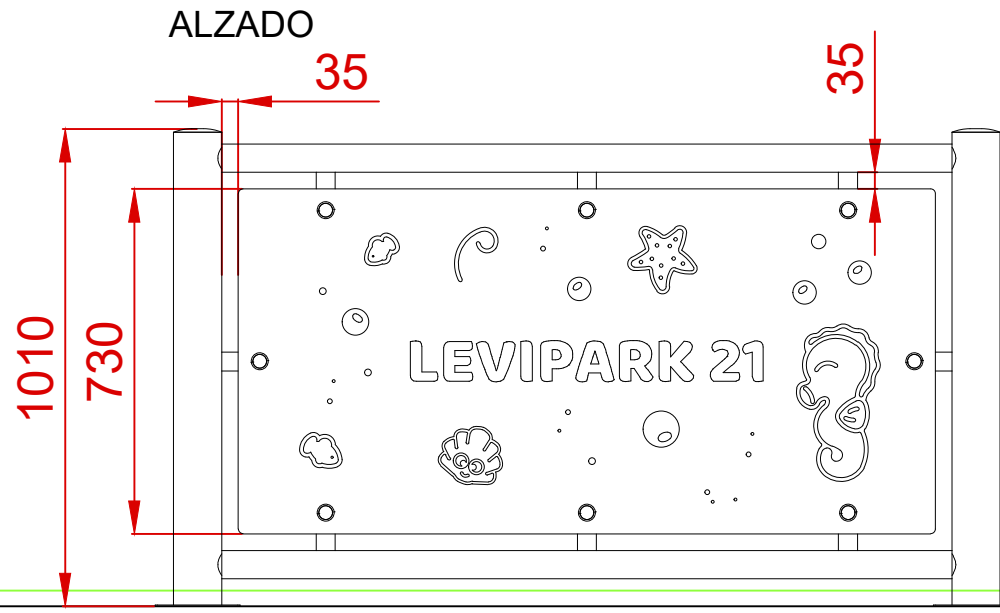

Dibujado		PLANO 1		Ref: MARVLL
Revisado		VISTAS GENERALES		
Aprobado		Descripción:	Escala:	Nº Hoja
		VALLA ENTRE MARES		2/3
			Fecha:	03/08/2021



PLANTA CIMENTACIÓN  
E: 2/1

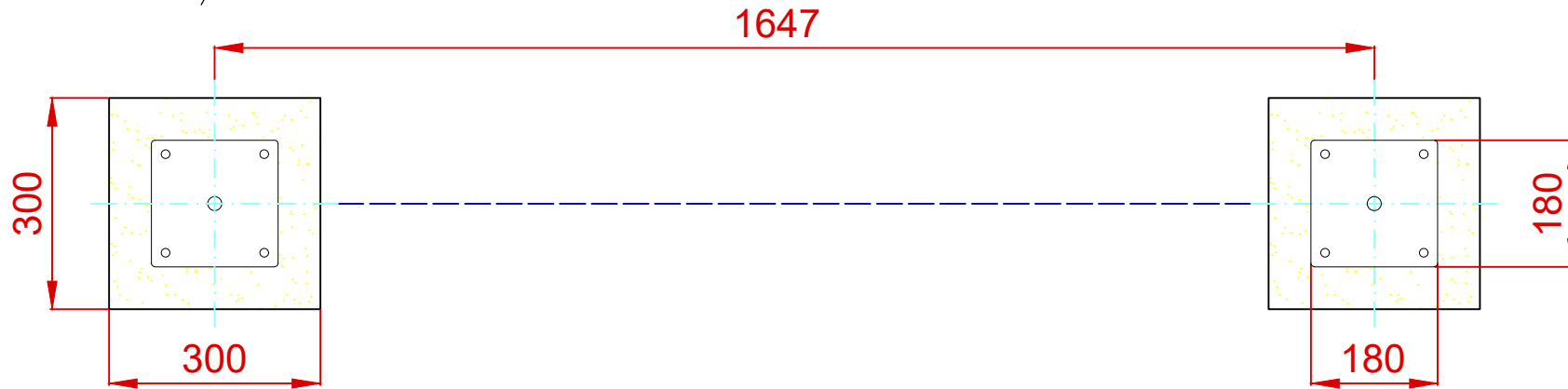

DETALLES CIMENTACIÓN  
ESQUEMA DE CIMENTACIÓN  
EN ARENA

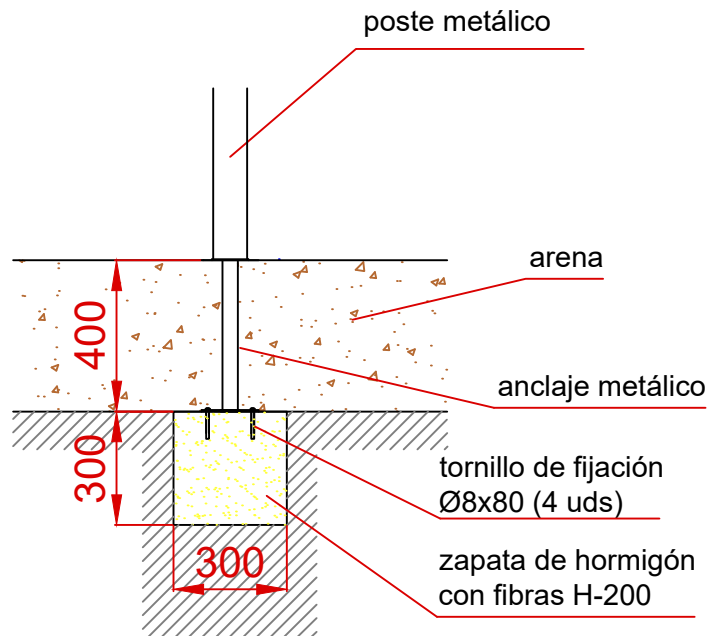

ESQUEMA DE CIMENTACIÓN  
EN HORMIGÓN

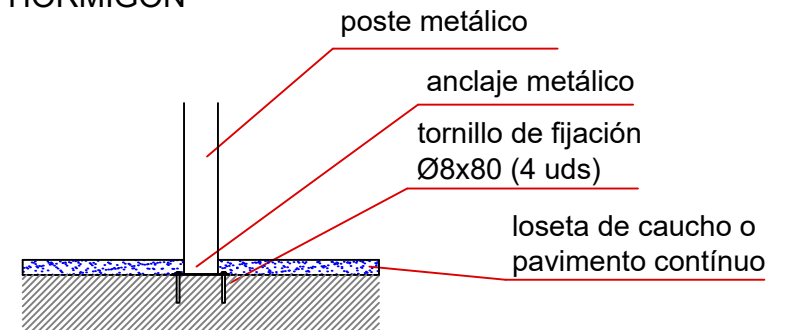

Dibujado		PLANO 2 CIMENTACIÓN Y ANCLAJES	Ref: MARVLL
Revisado			
Aprobado			
Descripción:		Escala:	Nº Hoja
VALLA ENTRE MARES			3/3
		Fecha:	03/08/2021



# MÓDULOS VALLA ENTRE MARES

VALLA ENTRE MARES 1

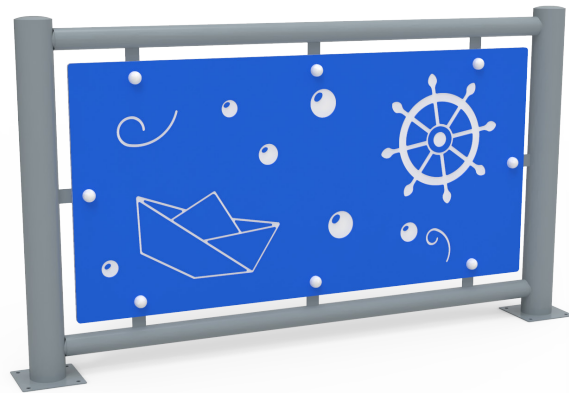

Ref.: MARVLL01

VALLA ENTRE MARES 2



Ref.: MARVLL02

VALLA ENTRE MARES 3

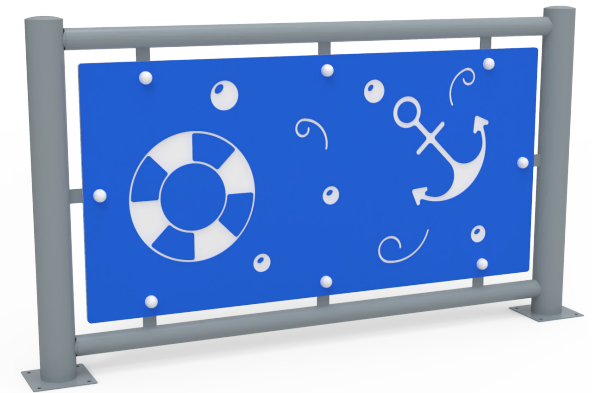

Ref.: MARVLL03