

DOCUMENTACIÓN TÉCNICA

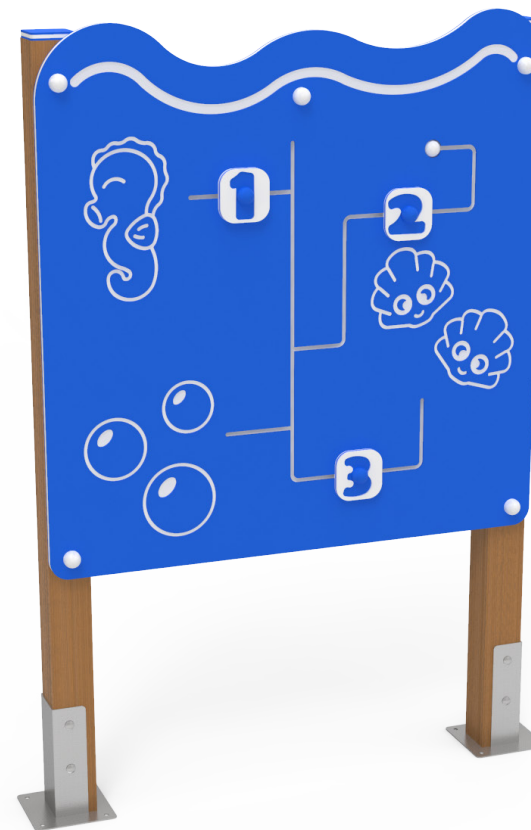
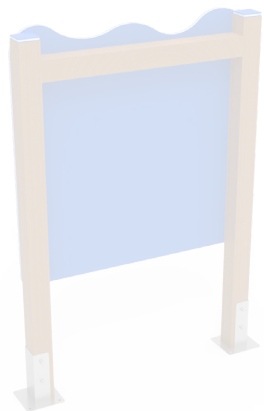

Ref.: MARCOM02

Panel interactivo “Burbujas”

UNE EN 1176-1:2018



Edad recomendada de uso: de 3 a 14 años
Postes de madera de pino tratada en autoclave Nivel IV
Componentes plásticos: Polietileno de alta densidad con protección UV
Tornillería protegida con tapones de polipropileno
Componentes metálicos galvanizados

ALZADO

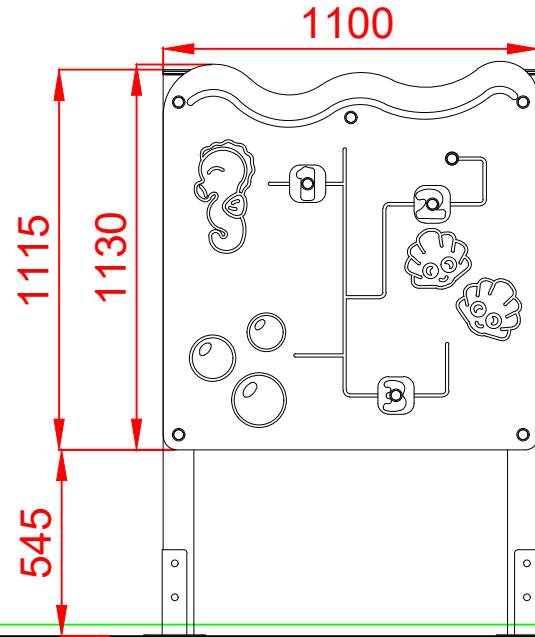

PERFIL IZQUIERDO

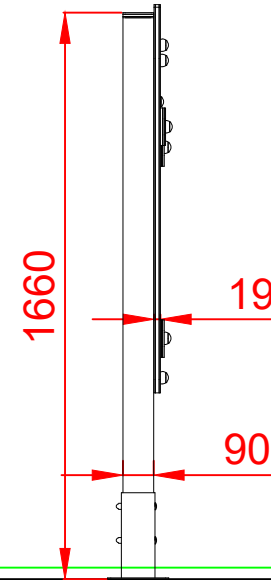

PLANTA

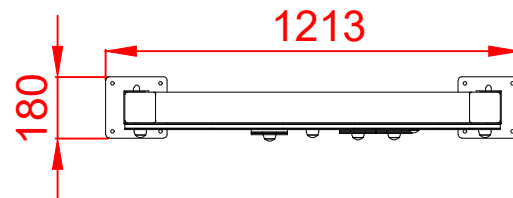

Dibujado		PLANO 1 VISTAS GENERALES	Ref: MARCOM02
Revisado			
Aprobado			
Descripción:		Escala:	Nº Hoja
PANEL INTERACTIVO "BURBUJAS"			2/3
		Fecha:	27/03/2024



DETALLES CIMENTACIÓN

ESQUEMA DE CIMENTACIÓN EN ARENA

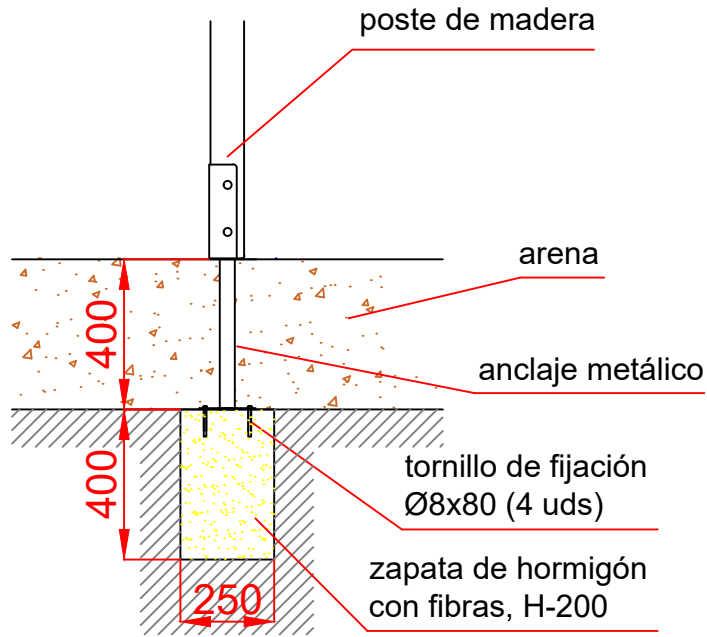

PLANTA CIMENTACIÓN E: 2/1

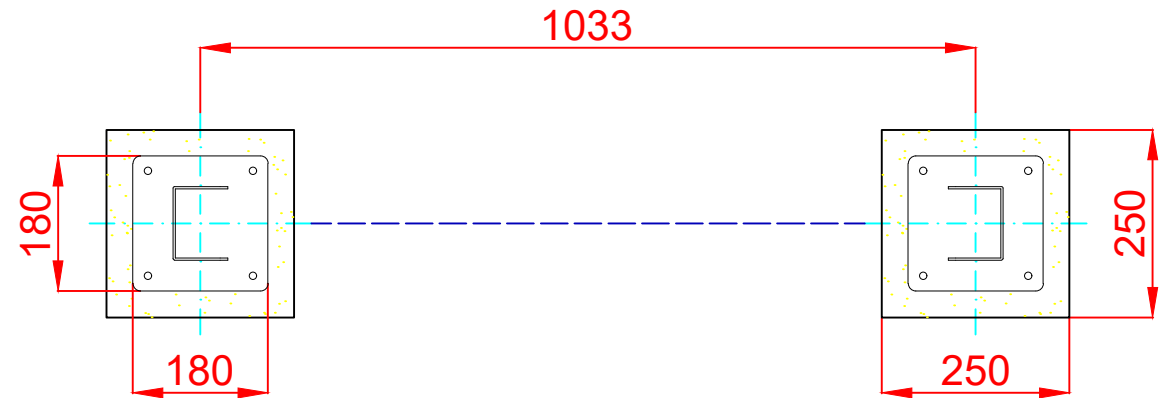

ESQUEMA DE CIMENTACIÓN EN HORMIGÓN

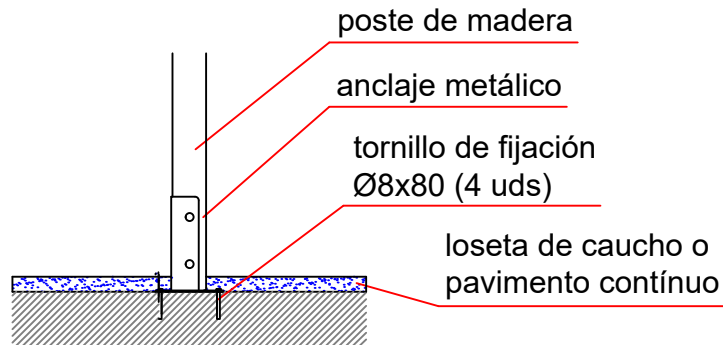

Dibujado		PLANO 2 CIMENTACIÓN Y ANCLAJES	Ref:	MARCOM02
Revisado				
Aprobado				
Descripción:		Escala:	Nº Hoja	
PANEL INTERACTIVO "BURBUJAS"			3/3	
		Fecha:	27/03/2024	

